

Specifications for LCD module

Customer	
Customer part no.	
Ampire part no.	AM-1024600DTZQW-THNH-A
Approved by	
Date	

Preliminary Specification

Formal Specification

APPROVED BY	CHECKED BY	ORGANIZED BY
Kokai	Mark	Lawlite

*This specification is subject to change without notice.

RECORD OF REVISION

Revision Date	Page	Contents	Editor
2021/10/01	-	New release	Lawlite

1. Features

It's a 7 inches Amorphous-TFT-LCD (Thin Film Transistor Liquid Crystal Display) module. This module is composed of a 7" TFT-LCD panel, LED backlight.

1. 7" TFT Liquid Crystal Display module
 - Construction: 7" a-Si TFT active matrix, White LED Backlight.
 - Resolution (pixel): 1024 RGB (H) x 600 (V)
 - Number of the Colors : 16.7M colors (R , G , B 8 bit digital each)
 - LCD type : Normally Black
2. Cover lens
 - Surface hardness: 7H min
 - T =1.1mm
 - Color: Black
3. Projective Capacitive Touch
 - a. Interface : USB
 - b. Touch Controller: [EETI EXC80W32](#)
 - c. Cover Lens : Tempered Soda Lime Glass : T=1.1mm.
 - d. Printing : Black border (Pantone:Black)
4. HDMI to LCD interface board:1024600D-H0 REV.C

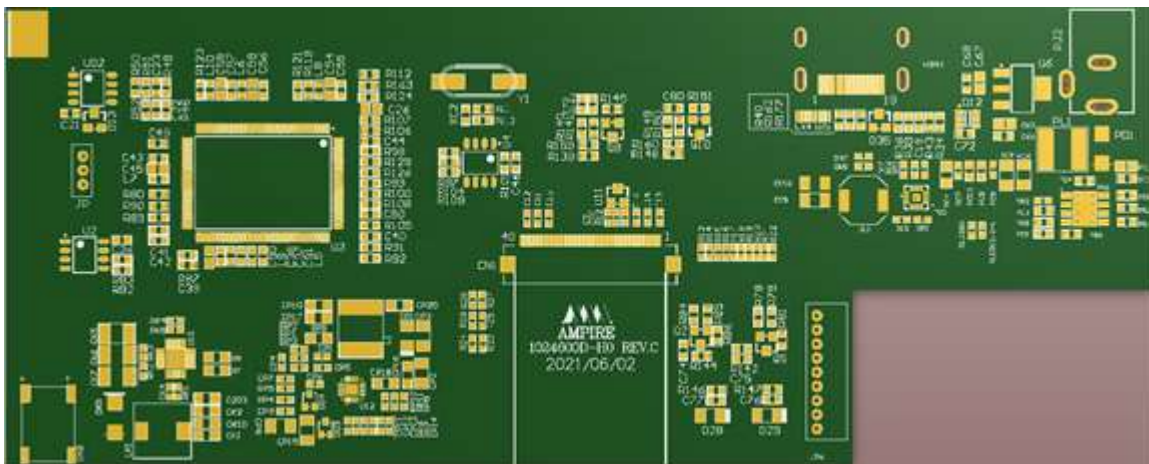

- New LED Driver : TPS61185
- Single Power input: 12V / 2A power input. (Connector: PJ2).
- HDMI Digital input : (Connector: HDMI1)
 - ◆ HDMI 1.4a Compliant
 - ◆ Single-link (Type A HDMI) on-chip TMDS receiver up to 225MHz. Support long cable.
 - ◆ Do not support HDCP.

■ Support input video format :

Resolution	V Sync	Resolution	V Sync
640x480	60	1280x800	60
640x480	72	1280x800	75
640x480	75	1280x960	60
800x600	56	1280x1024	60
800x600	60	1280x1024	75
800x600	72	1360x768	60
800x600	75	1366x768	60
848x480	60	1400x1050	60
1024x768	60	1400x1050	75
1024x768	70	1440x900	60
1024x768	75	1440x900	75
1152x864	75	1600x900	60
1280x720	60	1680x1050	60
1280x768	60	1680x1050	75
1280x768	75	1920x1080	60

2. PHYSICAL SPECIFICATIONS

Item	Specifications	unit
LCD size	7 inch (Diagonal)	
Resolution	1024 x (RGB) x 600	dot
Pixel pitch	0.1506(W) x 0.1432(H)	mm
Active area	154.2144(W) x 85.92(H)	mm
Color arrangement	RGB-stripe	

3. ABSOLUTE MAX. RATINGS

ITEM	SYMBOL	VALUES		UNIT	REMARK
		MIN	MAX		
Power Voltage	V _{IN}	-0.3	13	V	GND=0V, TA=25°C
Operation Temperature	T _{op}	-20	70	°C	
Storage Temperature	T _{st}	-30	80	°C	

Note 1: The absolute maximum rating values of this product are not allowed to be exceeded at any times. Should a module be used with any of the absolute maximum ratings exceeded, the characteristics of the module may not be recovered, or in an extreme case, the module may be permanently destroyed.

4. ELECTRICAL SPECIFICATIONS

4.1 Typical Operation Conditions (HDMI Interface Board)

Item	Symbol	Min	Typ	Max	Unit	Note
HDMI Interface Board Power Supply voltage	V_{IN}	11.5	12.0	12.5	V	
Power Consumption	I_{VIN}		T.B.D	1A		

4.2 Typical Operation Conditions (TFT LCD Module)

For Design reference only. These supply voltage and signals do not need to input by end user.

Item	Symbol	Min.	Typ.	Max.	Unit	Condition
Digital Power Supply Voltage	VDD	3.0	3.3	3.6	V	
Digital Power Supply Current	IDD		105		mA	
Differential Input High Threshold	VTH	--	--	100	mV	VCM=1.2V
Differential Input Low Threshold	VTL	-100	--	--	mV	
Input current	IIN	-10	--	+10	uA	
Differential input Voltage	VID	0.2	--	0.6	V	
Common Mode Voltage Offset	VCM	$\frac{ VID }{2}$	1.25	$2.4 \cdot \frac{ VID }{2}$	V	

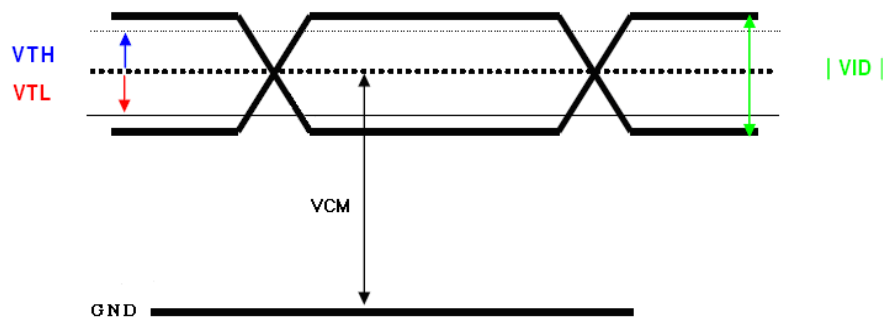

4.2.1 24-BIT LVDS Input Data Format

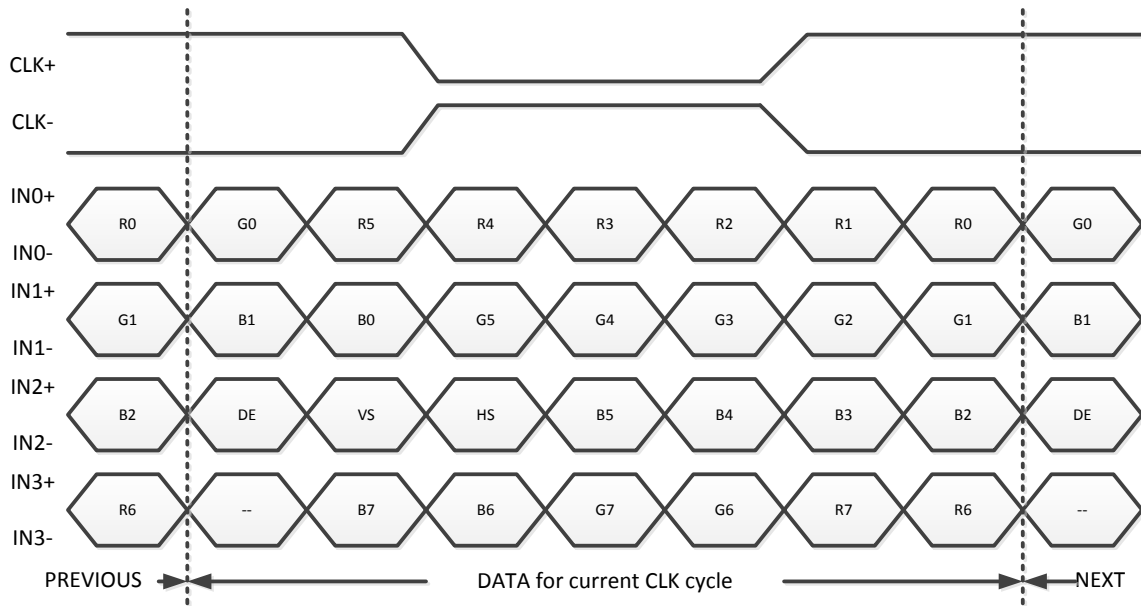

Note: R/G/B data 7: MSB, R/G/B data 0: LSB

Signal Name	Description	Remark
R7 R6 R5 R4 R3 R2 R1 R0	Red Data 7 (MSB) Red Data 6 Red Data 5 Red Data 4 Red Data 3 Red Data 2 Red Data 1 Red Data 0 (LSB)	Red-pixel Data Each red pixel's brightness data consists of these 8 bits pixel data.
G7 G6 G5 G4 G3 G2 G1 G0	Green Date 7 (MSB) Green Date 6 Green Date 5 Green Date 4 Green Date 3 Green Date 2 Green Date 1 Green Date 0 (LSB)	
B7 B6 B5 B4 B3 B2 B1 B0	Blue Data 7 (MSB) Blue Data 6 Blue Data 5 Blue Data 4 Blue Data 3 Blue Data 2 Blue Data 1 Blue Data 0 (LSB)	
CLK+ CLK-	LVDS Clock Input	
DE	Display Enable	
VS	Vertical Sync Signal	
HS	Horizontal Sync Signal	

4.2.2 Timing Table

LCD Interface Timing (DE mode)

Parameter	Symbol	Value			Unit
		Min.	Typ.	Max.	
DCLK frequency @Frame rate=60hz	fclk	40.8	51.2	67.2	Mhz
Horizontal display area	thd	1024			DCLK
HSYNC period time	th	1114	1344	1400	DCLK
HSYNC blanking	thb+thfp	90	320	376	DCLK
Vertical display area	tvd	600			H
VSYNC period time	tv	610	635	800	H
VSYNC blanking	tvb+tvfp	10	35	200	H

4. Backlight Driving Conditions

For Design reference only. These supply voltage and signals do not need to input by end user.

ITEM	SYMBOL	MIN	TYP	MAX	UNIT	NOTE
LED Driver Power Voltage	VLED	--	12	--	V	
LED Driver Power Current	I _{LED} (VLED=12V)	--	363	--	mA	Ta=25°C
PWM Dimming DC active level	V _{DIMH}	2.1	--	20	V	
	V _{DIML}	--	--	0.8	V	
PWM Dimming Freq.	FDIM	0.1		20	kHz	
BLEN Pin High Voltage	V _{BLENH}	2.1		20	V	
BLEN Pin Low Voltage	V _{BLENL}	--		0.8	V	
LED voltage	V _{AK}	--	26.4	--	V	Note 1
LED current	I _F	--	132	--	mA	Note 1
LED life time	--	--	50	--	kHrs	Note 2

Note (1) The LED Supply Voltage is defined by the number of LED at Ta=25°C and I_F=132 mA.

Note (2) The “LED life time” is defined as the module brightness decrease to 50% original brightness at Ta=25°C and I_F=132mA. The LED lifetime could be decreased if operating I_F is larger than 132mA.

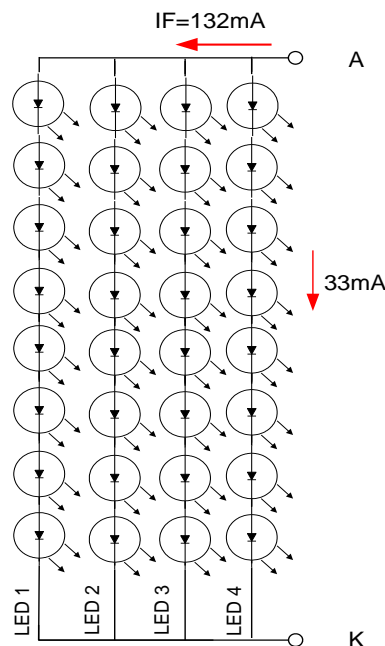

Note (3) When LCM is operated over 40°C ambient temperature, the IF should be follow :

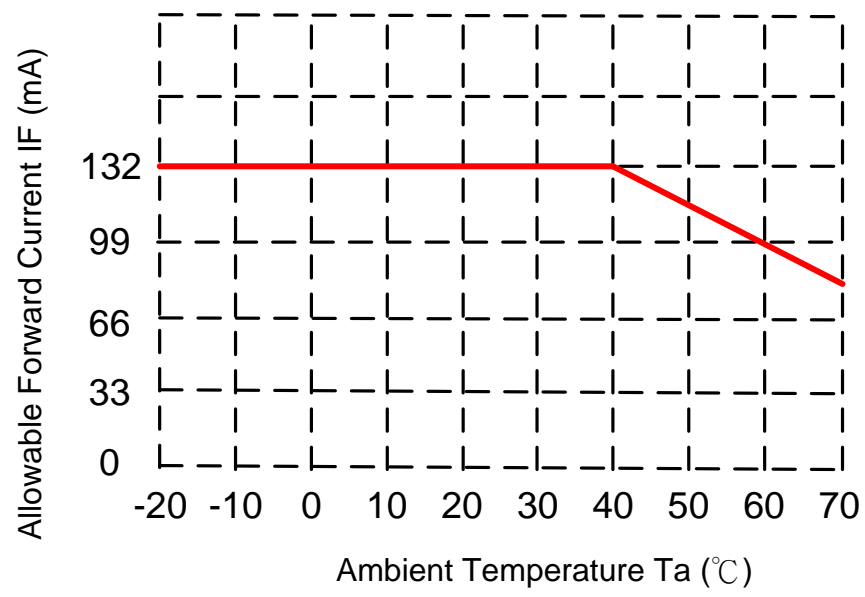

5. INTERFACE

5.1 INTERFACE (HDMI Interface Board)

- **PJ2 Power Supply Power Jack:**

Inner terminal is positive. Outer terminal is GND

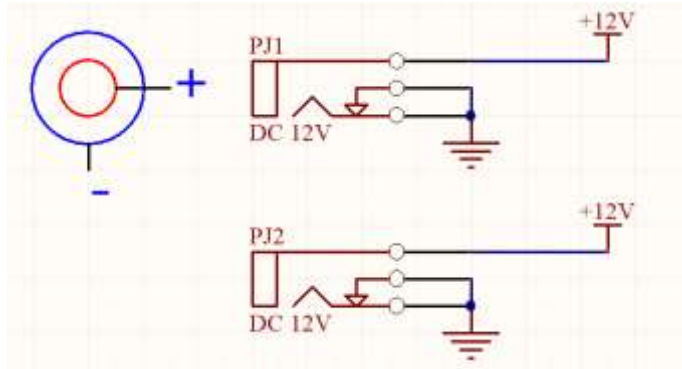

- **HDMI1: HDMI Type A Connector**

HDMI			
PIN	SIGNAL	PIN	SIGNAL
1	TMDS Data2+	11	TMDS Clock Shield (Ground)
2	TMDS Data2 Shield (Ground)	12	TMDS Clock-
3	TMDS Data2-	13	CEC (not used)
4	TMDS Data1+	14	Reserved (No Connection)
5	TMDS Data1 Shield (Ground)	15	SCL
6	TMDS Data1-	16	SDA
7	TMDS Data0+	17	DDC/CED (Ground)
8	TMDS Data0 Shield (Ground)	18	+5V input
9	TMDS Data0-	19	Hot Plug Detect
10	TMDS Clock+		

6. Optical Specifications

Item	Symbol	Condition	Values			Unit	Note
			Min.	Typ.	Max.		
Viewing angle (CR \geq 10)	θ L	$\Phi = 180^\circ$ (9 o'clock)	80	85	--	degree	Note1
	θ R	$\Phi = 0^\circ$ (3 o'clock)	80	85	--		
	θ T	$\Phi = 90^\circ$ (12 o'clock)	80	85	--		
	θ B	$\Phi = 270^\circ$ (6 o'clock)	80	85	--		
Response time	TON	Normal $\theta = \Phi = 0^\circ$	--	13	20	msec	Note3
	TOFF		--	15	25	msec	
Contrast ratio	CR		600	800	--	--	Note4
Color chromaticity	WX		0.26	0.31	0.36	--	Note5 Note6
	WY		0.31	0.36	0.41	--	
	RX		0.56	0.61	0.66		
	RY		0.29	0.34	0.39		
	GX		0.31	0.36	0.41		
	GY		0.52	0.57	0.62		
	BX		0.05	0.10	0.15		
	BY	0.03	0.08	0.13			
Luminance (central point)	L	680	850	--	cd/m ²	Note6	
Luminance uniformity	YU	70	75	--	%	Note6	

Test Conditions:

VDD = 3.3V, IF = 132 mA (Backlight current), the ambient temperature is 25°C.

The test systems refer to Note 2.

Note (1) Definition of viewing angle range

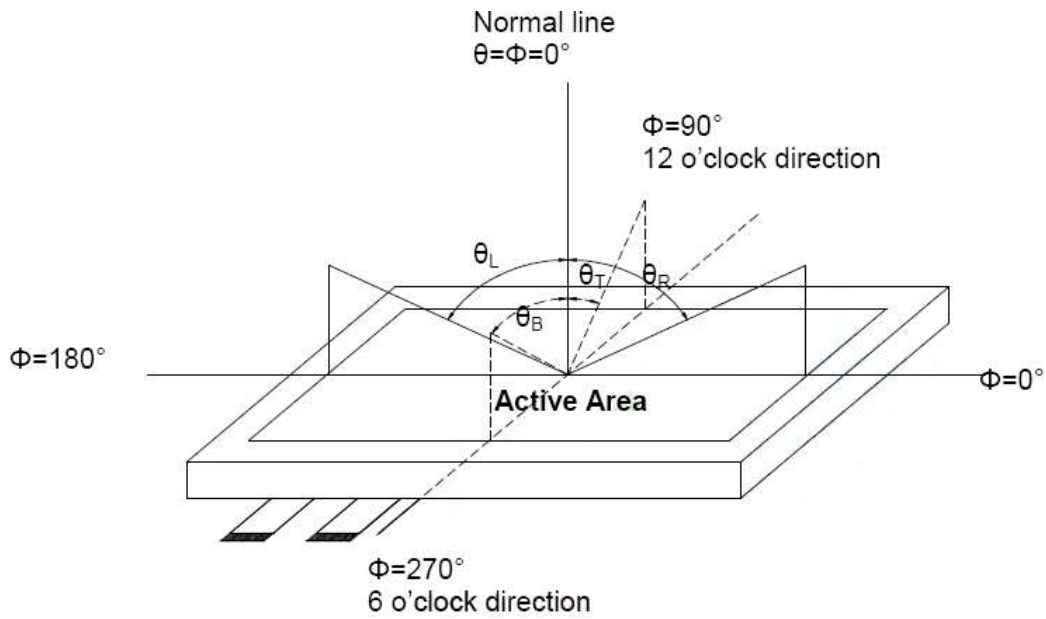

Note (2) Definition of optical measurement system

The optical characteristics should be measured in dark room. After 30 minutes operation, the optical properties are measured at the center point of the LCD screen. (Response time is measured by Photo detector TOPCON BM-7, other items are measured by BM-5A/Field of view: 1° / Height: 500mm.)

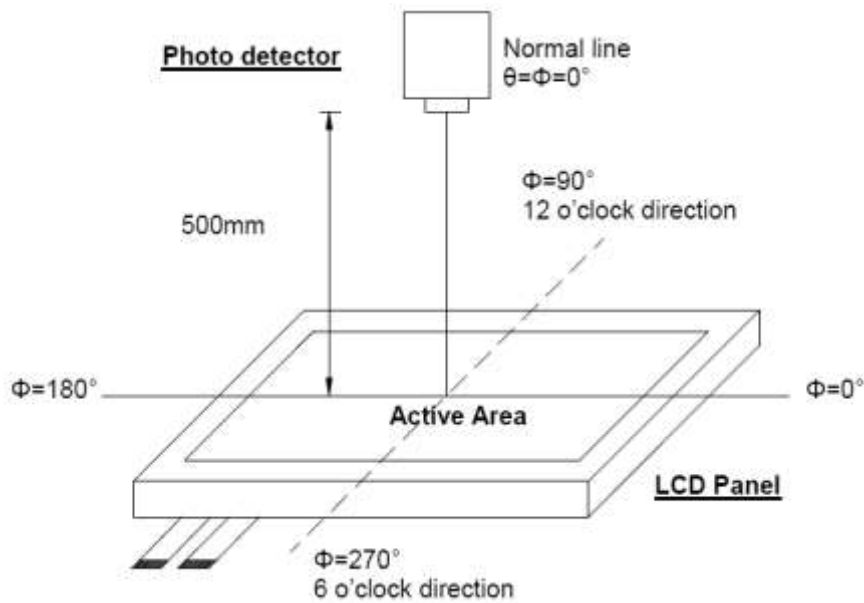

Note (3) Definition of Response time

The response time is defined as the LCD optical switching time interval between “White” state and “Black” state. Rise time (TON) is the time between photo detector output intensity changed from 90% to 10%. And fall time (TOFF) is the time between photo detector output intensity changed from 10% to 90%.

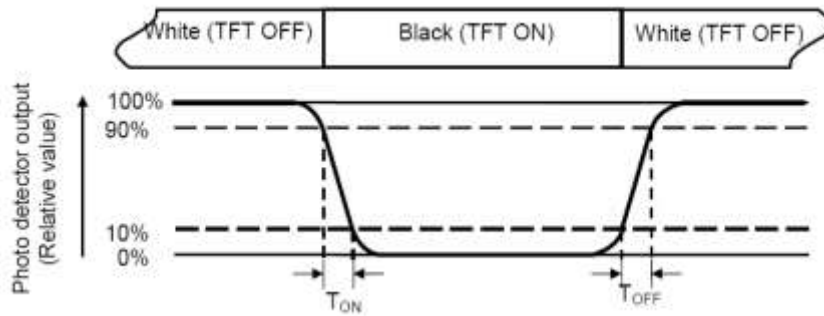

Note (4) Definition of contrast ratio

$$\text{Contrast ratio (CR)} = \frac{\text{Luminance measured when LCD on the "White" state}}{\text{Luminance measured when LCD on the "Black" state}}$$

Note (5) Definition of color chromaticity (CIE1931)

Color coordinated measured at center point of LCD.

All input terminals LCD panel must be ground when measuring the center area of the panel.

Note (6) Definition of Luminance Uniformity

Active area is divided into 9 measuring areas (Refer to bellow figure).

Every measuring point is placed at the center of each measuring area.

$$\text{Luminance Uniformity (Yu)} = \frac{B_{\min}}{B_{\max}}$$

L ----- Active area length W ----- Active area width

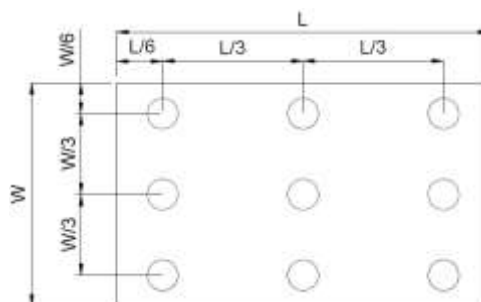

Bmax : The measured maximum luminance of all measurement position.

Bmin : The measured minimum luminance of all measurement position.

Note (7) Pixel format

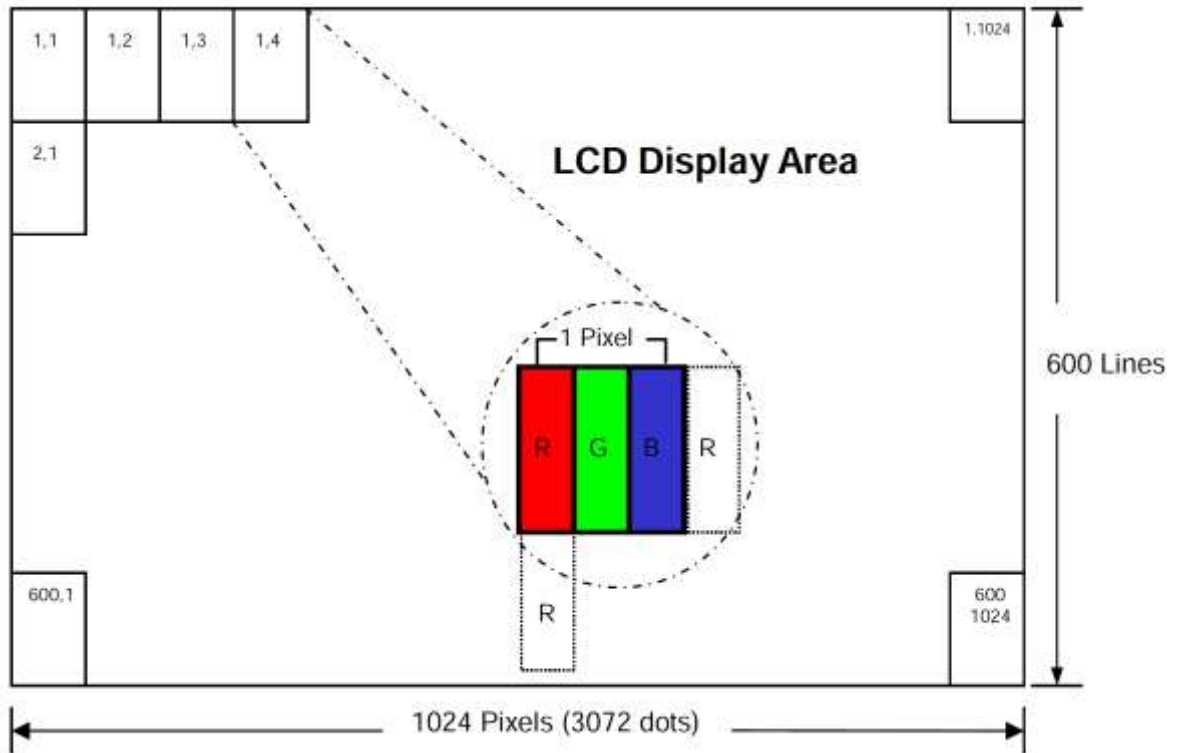

7. Projected capacitive-type TOUCH PANEL ELECTRICAL SPECIFICATION

Basic Characteristic

ITEM	SPECIFICATION
Type	Projective Capacitive Touch Panel
Activation	Multi-finger
X/Y Position Reporting	Absolute Position
Touch Force	No contact pressure required
Calibration	No need for calibration
Report Rate	Approx. 100 points/sec
Interface	USB
Control IC	EXC80W32
Cover Glass	1.1mm chemically strength glass with black border
Bonding method	CG to sensor: optical bonding
	TP module to LCM: tape bonding

Specify the normal operating condition
(GND=0V)

Item	Symbol	Min.	Typ.	Max.	Unit	Note
Power Supply Voltage	VIN	4.75	5.0	5.25	V	
Power Current	IIN		TBD			

Interface

Pin No.	Symbol	Function
1	GND	POWER GND
2	DA-	USB Data-
3	DA+	USB Data+
4	VIN	USB power input 5V
5	NA	No connection
6	NA	No connection

8. RELIABILITY TEST CONDITIONS

Test Item	Test Conditions	Note
High Temperature Operation	70±3°C ,Dry t=240 hrs	
Low Temperature Operation	-20±3°C, Dry t=240 hrs	
High Temperature Storage	80±3°C , Dry t=240 hrs	1,2
Low Temperature Storage	-30±3°C ,Dry t=240 hrs	1,2
Thermal Shock Test	-20°C ~ 25°C ~ 70°C 30 m in. 5 min. 30 min. (1 cycle) Total 100 cycle(Dry)	1,2
Storage Humidity Test	60 °C, Humidity 90%, 240 hrs	1,2
Vibration Test (Packing)	Sweep frequency : 10 ~ 55 ~ 10 Hz/1min Amplitude : 0.75mm Test direction : X.Y.Z/3 axis Duration : 30min/each axis	2

Note(1) Condensation of water is not permitted on the module.

Note(2) The module should be inspired after 1 hour storage in normal conditions (15~35°C, 45~65%RH).

Note(3) The module shouldn't be tested over one condition, and all the tests are independent.

Note(4) All reliability tests should be done without the protective film.

Definitions of life end point:

- Current drain should be smaller than the specific value.
- Function of the module should be maintained.
- Appearance and display quality should not have degraded noticeably.
- Contrast ratio should be greater than 50% of initial value.

9. General Precautions

9.1 Safety

- (1) Liquid crystal is poisonous. Do not put it your mouth. If the liquid crystal touches you skin or clothes, you need to wash it off immediately with the soap and water.

9.2 Handling

- (1) The LCD panel is plate glass. Do not subject the panel to mechanical shock or excessive force on its surface.
- (2) The polarizer which attached to the display is easily damaged. Please handle it carefully to avoid scratch or other damages.
- (3) To avoid contamination on the display surface, do not touch the module surface with bare hands.
- (4) Keep a space so that the LCD panels do not touch other components.
- (5) Put on cover board such as acrylic board, which covers on the surface of LCD panel to protect panel from damages.
- (6) Transparent electrodes may be disconnected if you use the LCD panel under environmental conditions where the condensation of dew occurs.
- (7) Do not leave module in direct sunlight to avoid malfunction of the ICs.

9.3 Mechanism

- (1) Please mount LCD module by using mounting holes arranged in four corners tightly.

9.4 Static Electricity

- (1) Be sure to ground module before you turn on power or operation module.
- (2) Do not apply voltage which exceeds the absolute maximum rating value.

9.5 Storage

- (1) Store the module in a dark room where it must keep at $+25\pm 10^{\circ}\text{C}$ and 65%RH or less.
- (2) Do not store the module in surroundings which are containing organic solvent or corrosive gas.
- (3) Store the module in an anti-electrostatic container or bag.

9.6 Cleaning

- (1) Do not wipe the polarizer with dry cloth. It might cause scratch.
- (2) Only use a soft sloth with IPA to wipe the polarizer, other chemicals might permanent damage to the polarizer.

9.7 Others

- (1) AMIPRE will provide one year warrantee for all products and three months warrantee for all repairing products.
- (2) Do not apply fixed pattern data signal to the LCD module as you are using the product.

10. OUTLINE DIMENSION

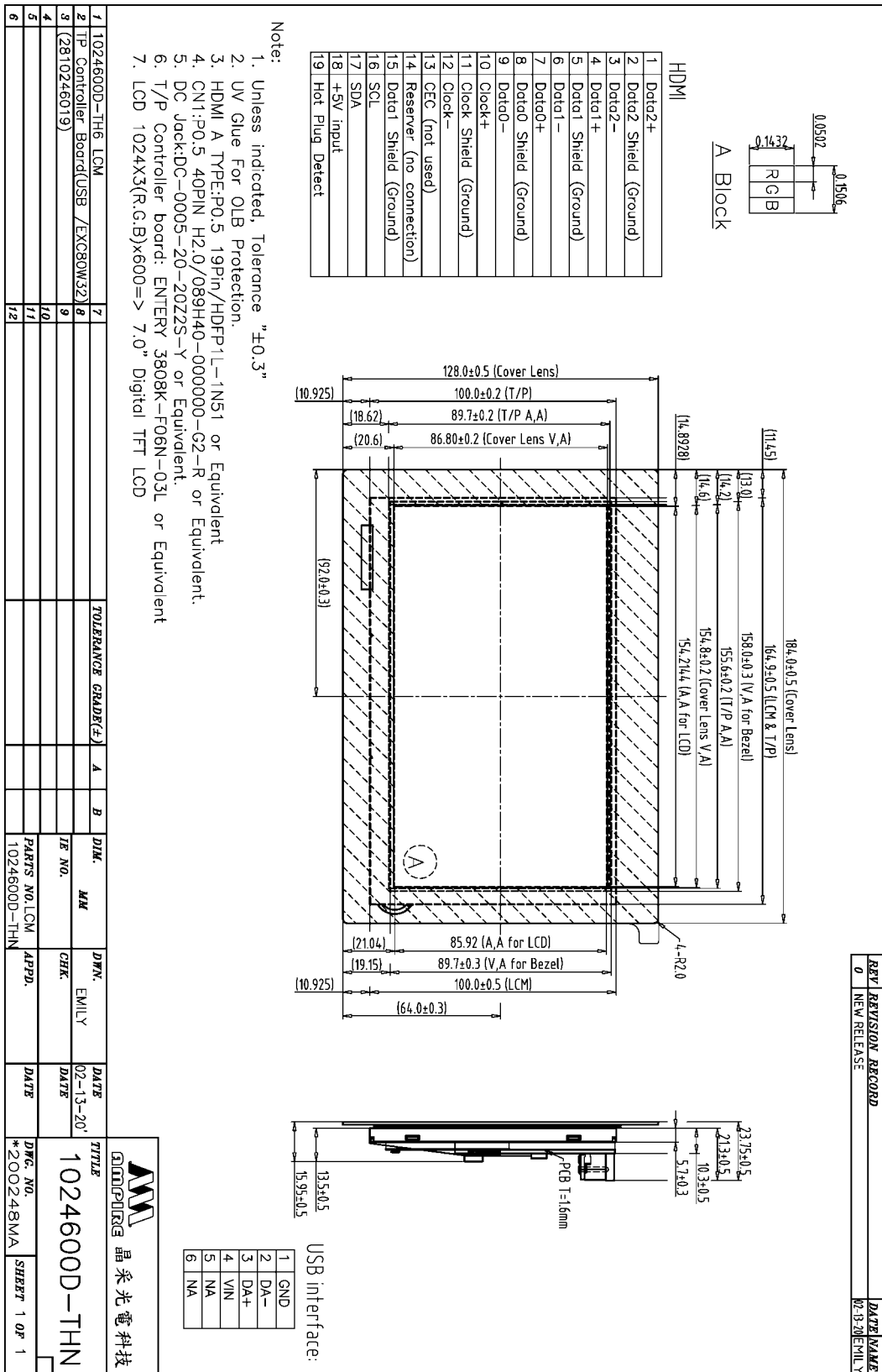

REV	REVISION RECORD	DATE	NAME
0	NEW RELEASE	02-13-20	EMILY

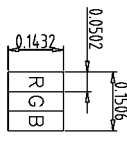

A Block

HDMI

1	Data2+
2	Data2 Shield (Ground)
3	Data2-
4	Data1+
5	Data1 Shield (Ground)
6	Data1-
7	Data0+
8	Data0 Shield (Ground)
9	Data0-
10	Clock+
11	Clock Shield (Ground)
12	Clock-
13	CEC (not used)
14	Reserver (no connection)
15	Data1 Shield (Ground)
16	SCL
17	SDA
18	+5V input
19	Hot Plug Detect

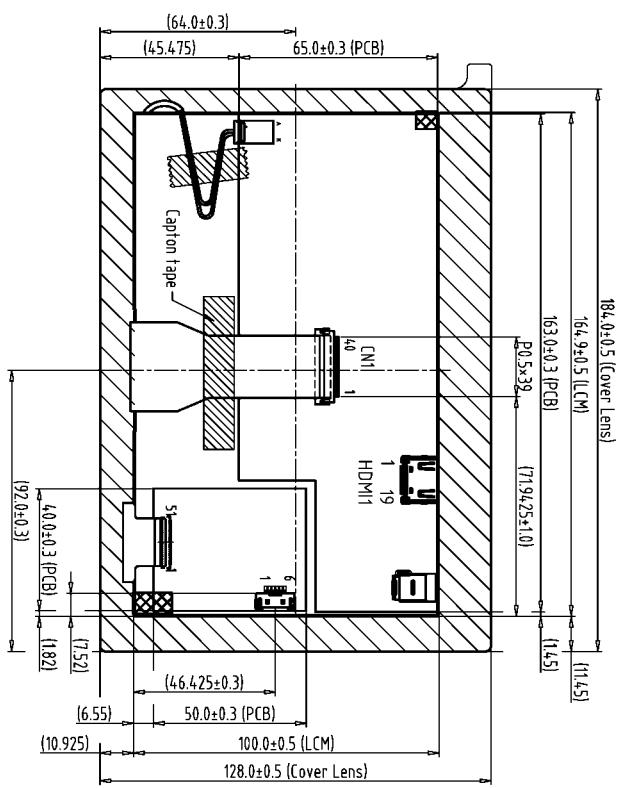

Back View

USB interface:

1	GND
2	DA-
3	DA+
4	VIN
5	NA
6	NA

- Note:
1. Unless indicated, Tolerance "±0.3"
 2. UV Glue For OLB Protection.
 3. HDMI A TYPE:P0.5 19Pin/HDFP1L-1N51 or Equivalent
 4. CN1:P0.5 40PIN H2.0/089H40-000000-G2-R or Equivalent.
 5. DC Jack:DC-0005-20-20Z2S-y or Equivalent.
 6. T/P Controller board: ENTERY 3808K-F06N-03L or Equivalent
 7. LCD 1024X3(R.G.B)x600=> 7.0" Digital TFT LCD

1	1024600D-TH6 LCM	7		TOLERANCE GRADIENT(±)	A	B	DIM.	MM	DWN.	EMILY	DATE	02-13-20	TITLE	1024600D-THN	DWG. NO.	*200249MA	SHEET	1 OF 1
2	TP Controller Board(USB /EXCG0W32)	8									DATE							
3	(2810246019)	9									DATE							
4		10									DATE							
5		11									DATE							
6		12									DATE							

晶采光電科技
1024600D-THN
 DWG. NO. *200249MA
 SHEET 1 OF 1